

# The Industry Leader in Architectural Hardware and Door Security Products

# DON-JO MFG., INC.

## Introducing the Don-Jo “Frame Frog”



The first backbox specifically designed for electrified door hardware in hollow metal door frames providing a smooth, seamless wiring pathway and future-proofing door hardware wiring access. The universal design offers an easy, professional solution for all electronic locks, strikes, card readers, and any other devices of a fully operational access control system.

- Designed to attach to hollow metal door frames that require wiring systems for electronic door hardware and access control devices.
- Easily install electrical hardware such as electric locks, strikes, card readers, EPT's, position switches, etc.
- Universal, flexible design simplifies ordering and allows for adaptation in the field for all hardware types and locations in a door frame.
- Continues to be accessible through entry points that remain after construction is completed, allowing for future changes and upgrades.
- Designed for use with ½ inch PVC conduit and standard 90° sweeps within the doorframe.

**Part Number: WP4L-001**

**List Price: \$68.00**

# The Industry Leader in Architectural Hardware and Door Security Products

# DON-JO MFG., INC.

## Introducing the Don-Jo "Frame Frog"



### KEY FEATURES:

- Unique patented shape forces fish tape down chosen conduit paths with the flick of a finger.
- Adjustable wing tabs allow for anchoring to a variety of door frame depths.
- Attachment Screw rotates and raises wing tab behind the frame return to secure FRAMEFROG in place.
- Triangular knockouts are easily removed to provide clearance for door hardware prep that is welded in the frame.
- Funnel-shaped ports smoothly direct a fish tape into electrical conduit.
- Four connection ports for attaching and configuring conduit pathways in multiple arrangements.
- Dividers that separate the ports for ease in steering the fish tape into the desired port.
- Port caps are easily removed for conduit attachment and remain in place for unused connections.



Simply change wiring path direction with the push of a finger.

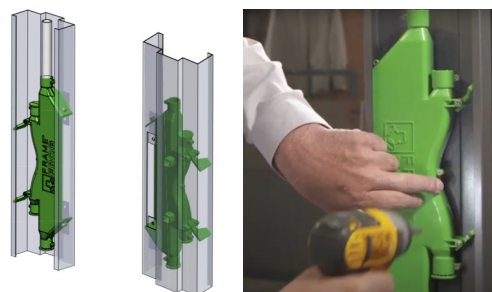

Offset port design provides clearance for standard 90° conduit to turn down and remain within the frame.

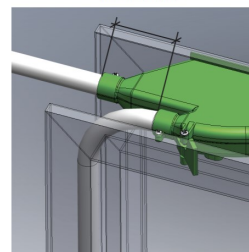

# INSTALLATION GUIDE

## FrameFrog 4 Port - 9" Opening

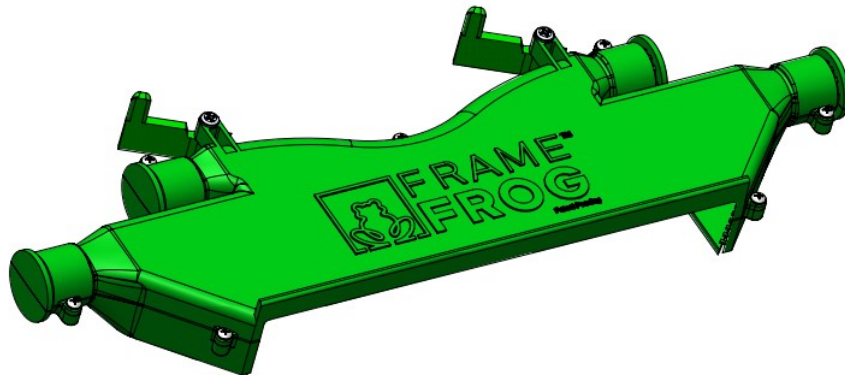

Get your  
Instructions  
Online.



SCAN ME

### FrameFrog Parts Diagram

- A – Port A
- B – Port B
- C – Wing Tab
- D – Screw
- E – Port Caps
- F – Knockouts

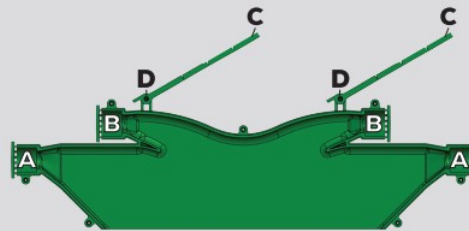

FRONT

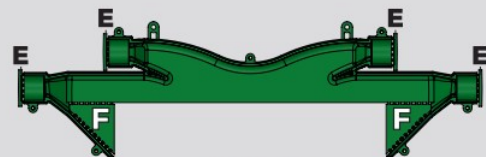

BACK

### Preparing Door Frame

1. Provide FrameFrog where electric door hardware devices are to be installed or are planned in the future.
2. Omit mortar boxes from door frame supplier where ever FrameFrog is to be installed. FrameFrog replaces the mortar box.
3. Hollow metal door frame supplier should supply wire frame type anchors for masonry frames and flush Z type anchors (notched) for drywall frames in order to provide clearance for conduits. T anchors and other shapes will conflict with the installation of conduit that is housed within the frame.

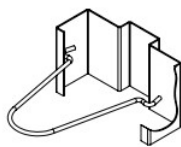

Wire Anchor

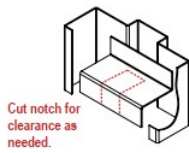

Flush Z

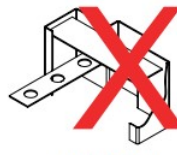

Loose T-Strap  
(Masonry)

1

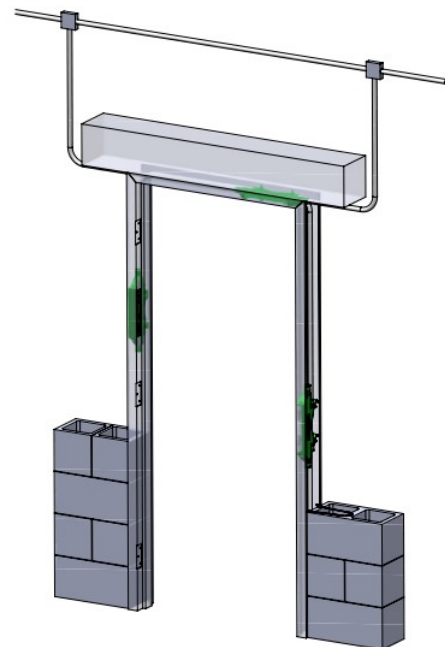



## FrameFrog Preparation

1. Remove excess portion of Wing Tab (C) for corresponding depth of door frame, and discard excess.
2. Remove port caps (E) where conduit is to be connected. Use pliers or flathead screwdriver to pry cap off of port. Leave all other caps in place for connection by others in the field, and to prevent mortar from entering FrameFrog.
3. Tape or seal caps if needed to prevent high slump mortar from entering FrameFrog.
4. Remove triangular crackoff (F) where required for clearance with some door frame hardware prep (for example, EPT devices).

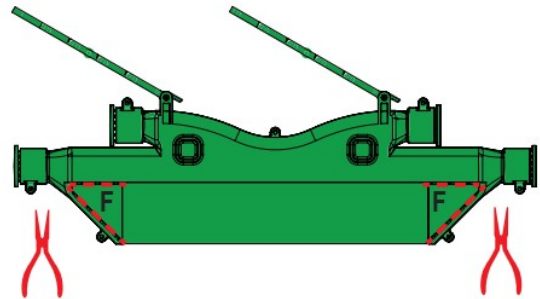
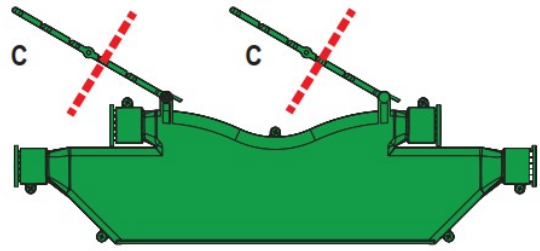
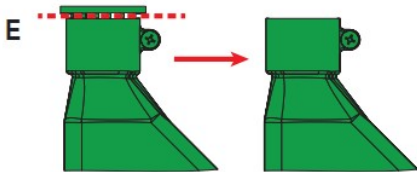

## FrameFrog Installation

1. Insert FrameFrog by placing the tab under the back hem of the frame, and rotating down into the frame to cover the door hardware prep.
2. Once FrameFrog is in the door frame, slide into position where opening is centered on the hole in the door frame.
3. For units at the head of the frame, verify that Rear Port is set back approximately 3" - 4" from the outside corner of the frame. This may require removal of one of the triangular knockouts (F). When located properly, a standard sweep conduit will drop down into the side of the frame and avoid conflict with future construction.
4. Use a screw gun (or screw driver) to rotate wing tabs (C) under the opposite back hem of the frame. Continue screwing so that wing tab rises up tight to the back of the hem to lock the box in place.
5. Caution: DO NOT overtighten screws and tear plastic pilot hole of the wing tab. Use low speed, and stop once FrameFrog is tight.

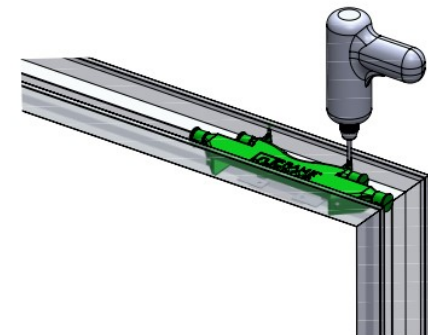
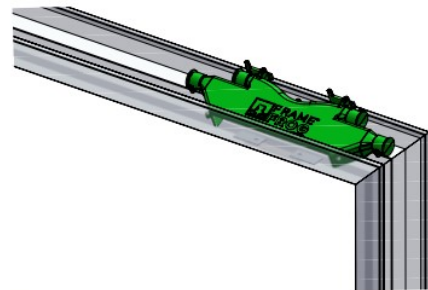

## Wing Tab Additional Support

For door frames wider than 6 3/4", the Wing Tab contains a pilot hole for additional support by inserting a #6 screw as show. (Screws are not provided). For 7 3/4" frames, use 1 1/2" screw; for all others, use 2" long screws.

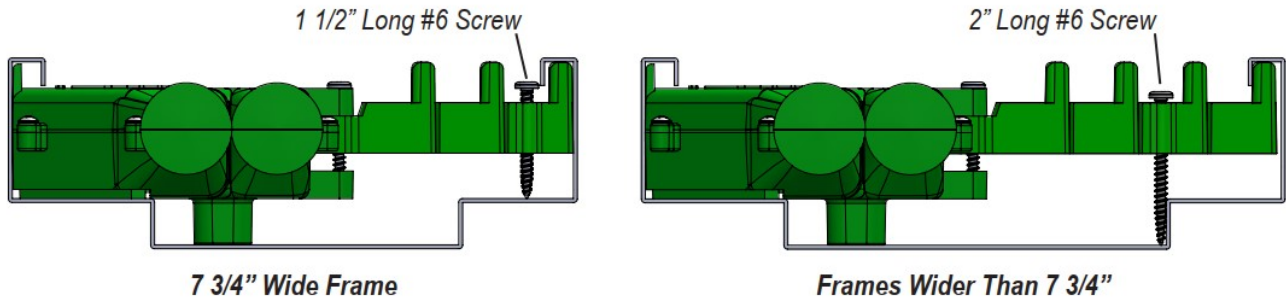

## Connecting Electrical Metal Tubing (EMT)

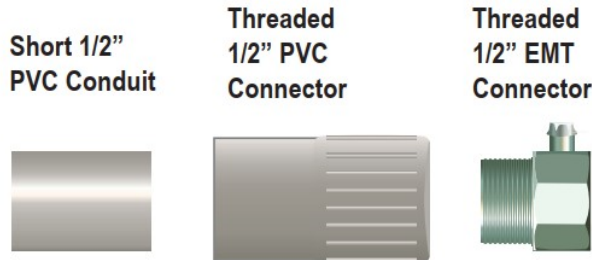

PARTS NEEDED

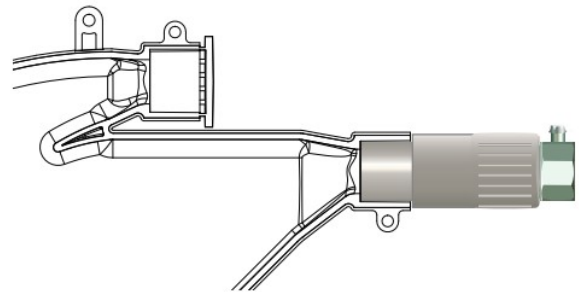

PARTS ASSEMBLED

## Recommended Conduit Configuration

While there are multiple conduit configurations available, we recommend using a consist convention of pathways such as the basic configuration demonstrated here. This will prove to be beneficial when running wires at the time when FrameFrog and conduits are concealed from view. By connecting **Port B** to **Port B**, you will know that these pathways remain within the door frame. This reserves **Port A** for exiting the frame and extending to various remote locations, such as card readers, above ceiling power supplies, etc..

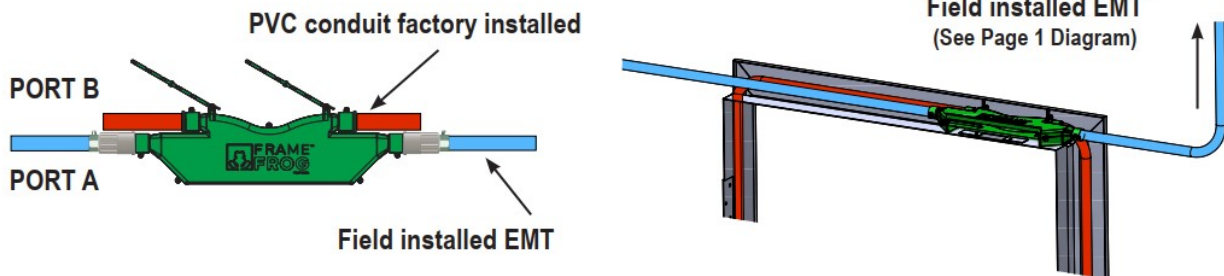



## FrameFrog Use

1. Once door frame, FrameFrog, and walls are all in place, an electrician's fish-tape can be used to fish and pull wires from any location in the frame. Insert fish-tape into opening of frame and FrameFrog, and direct fish-tape side to side to enter the desired port and conduit.
2. It is highly recommended to use a fiberglass fish-tape. Flat metal fish-tapes do not bend equally in all directions, and can reduce the ability to control the fish-tape's path.
3. When pushing a fish-tape through a FrameFrog to a location further downstream, the fish-tape will naturally enter Port A and exit the frame. In order to direct the fish-tape to enter Port B and remain in the frame, simply use index finger to push the fish-tape behind the diverter, and continue pushing.

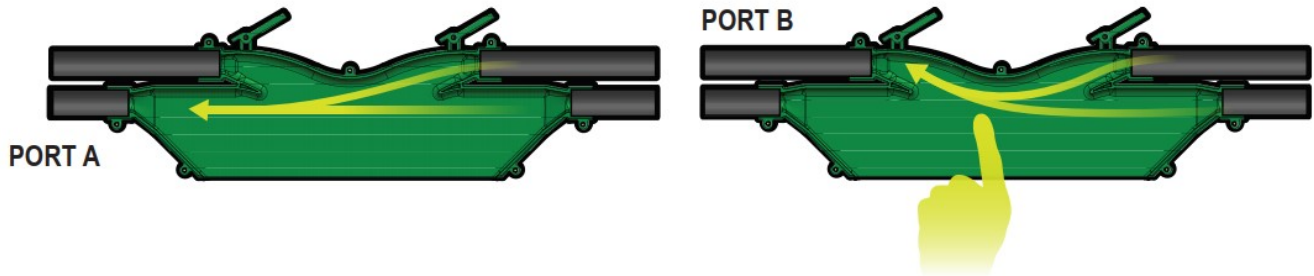

## Door Frame QR Code Label Location

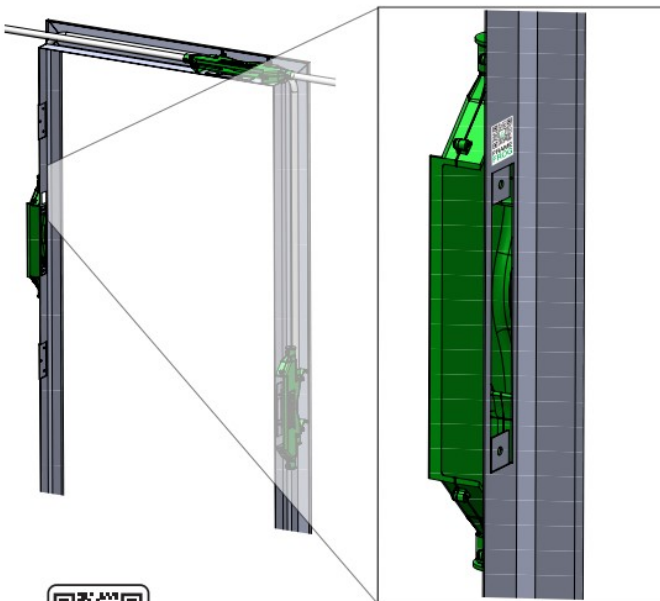

Apply QR Code Decal  
on Hinge Side at Face  
of Door Rabbet

## ⚠ Cautions

1. FrameFrog should be used in conjunction with a qualified electrician.
2. Tape or otherwise seal all openings of the remaining port caps to keep high slump mortar from entering FrameFrog.
3. Once installed in the frame, fill all voids between FrameFrog and the door frame that might allow high slump mortar to enter.
4. When attaching pvc conduit to FrameFrog, use Multipurpose Adhesive made for bonding PVC to ABS Plastic.
5. FrameFrog should only be used for wiring systems of less than 30 volts.
6. Limited for "Class 2 Single Source" power supplies only.
7. Convert conduits that exit the frame to EMT when required by codes.
8. Comply with all authorities having jurisdiction as well as all National, State, and Local Building Codes.

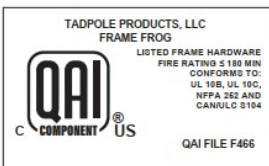

# DON-JO MFG., INC.

US Patent and Trademark Office  
Patent Nos. 10,411,447 & 10,855,064

